

) david
trubridge



Floral



Floral



Designed to offer a softer more decorative offering alongside Coral which is more structured. Floral was designed three years after Coral light, based on a geometric polyhedra forms. Floral was designed to offer a softer more decorative offering alongside Coral which is more structured. Floral comes in 5 sizes. The plywood finish can be all natural or painted on one side thus creating a stock selection of 11 options including black.



Features

Shipped Kitset

Seed System kitset lightshades are on average 1/30th of the volume of the assembled light. This aims to help minimize the effects of shipping and to reduce the design's environmental footprint.

Compliance

CE (IEC 60598.2.1 Ed 1.1 IEC 60598.1 Ed 8.0)
AS/NZS (AS/NZS 60598.2.1)

Note: UL/cUL certified cordsets are supplied within the North American market sourced from UL/cUL manufacturers.

Care Instructions

All wooden and/or polycarbonate lights are intended for use in dry interior conditions only and can be cleaned with a soft cloth dampened slightly in warm soapy water when the light is switched off. Do not use detergents.

Light sizes

David Trubridge kitset lightshades come in various sizes, making it easy to find the right size to any interior space whether it's small or large.

EPD Certified

An EPD is a standardised and verified way of quantifying the environmental impacts of a product, based on a consistent set of rules that have been developed through a stakeholder consultation process.

Warranty

This light is warranted for three years from date of purchase for failure of parts.



Technical Data



400mm/16"

600mm/24"

800mm/31"

1000mm/39"

1200mm/47"

1600mm/63"

Diameter: 400mm / 16"	Diameter: 600mm / 24"	Diameter: 800mm / 31"	Diameter: 1000mm / 39"	Diameter: 1200mm / 47"	Diameter: 1600mm / 63"	Dimensions Cordset* Material Fasteners Suspension Packaging
Weight: 0.4kg / 0.88lb	Weight: 1kg / 2.20lb	Weight: 1.5kg / 3.30lb	Weight: 2.3kg / 5.07lb	Weight: 3.8kg / 8.37lb	Weight: 9kg / 19.84lb	
2m / 6.5ft	2m / 6.5ft	2m / 6.5ft	3m / 9.8ft	5m / 16.4ft	5m / 16.4ft	
Bamboo plywood (Sourced from FSC accredited factory)	Bamboo plywood (Sourced from FSC accredited factory)	Bamboo plywood (Sourced from FSC accredited factory)	Bamboo plywood (Sourced from FSC accredited factory)	Bamboo plywood (Sourced from FSC accredited factory)	Bamboo plywood (Sourced from FSC accredited factory)	
Nylon	Nylon	Nylon	Nylon	Nylon	Aluminium	
Hangs on cord	Hangs on cord	Hangs on cord	1 x Suspension Wire	1 x Suspension Wire	1 x Suspension Wire	
290 x 165 x 75 11" x 6" x 3" 0.004m ³ / 0.141ft ³ 0.8kg / 1.76lb	360 x 250 x 85 14" x 10" x 3" 0.008m ³ / 0.283ft ³ 1.2kg / 2.65lb	360 x 250 x 130 14" x 10" x 5" 0.012m ³ / 0.423ft ³ 2kg / 4.41lb	365 x 320 x 140 14" x 10" x 6" 0.016m ³ / 0.577ft ³ 2.7kg / 5.95lb	365 x 425 x 125 14" x 17" x 5" 0.019m ³ / 0.671ft ³ 4.2kg / 9.25lb	470 x 395 x 180 19" x 16" x 7" 0.033m ³ / 1.165ft ³ 9.5kg / 20.94lb	

*Black Stain comes with black cordset and fasteners. All others come with white cordset and clear fasteners.

You will need

Fixings for cone gripper (fixing screws NOT SUPPLIED).

Note: Choose appropriate hardware to attach base plate (Fig.1) to ceiling substrate.

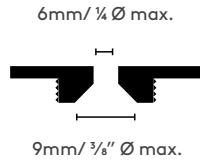
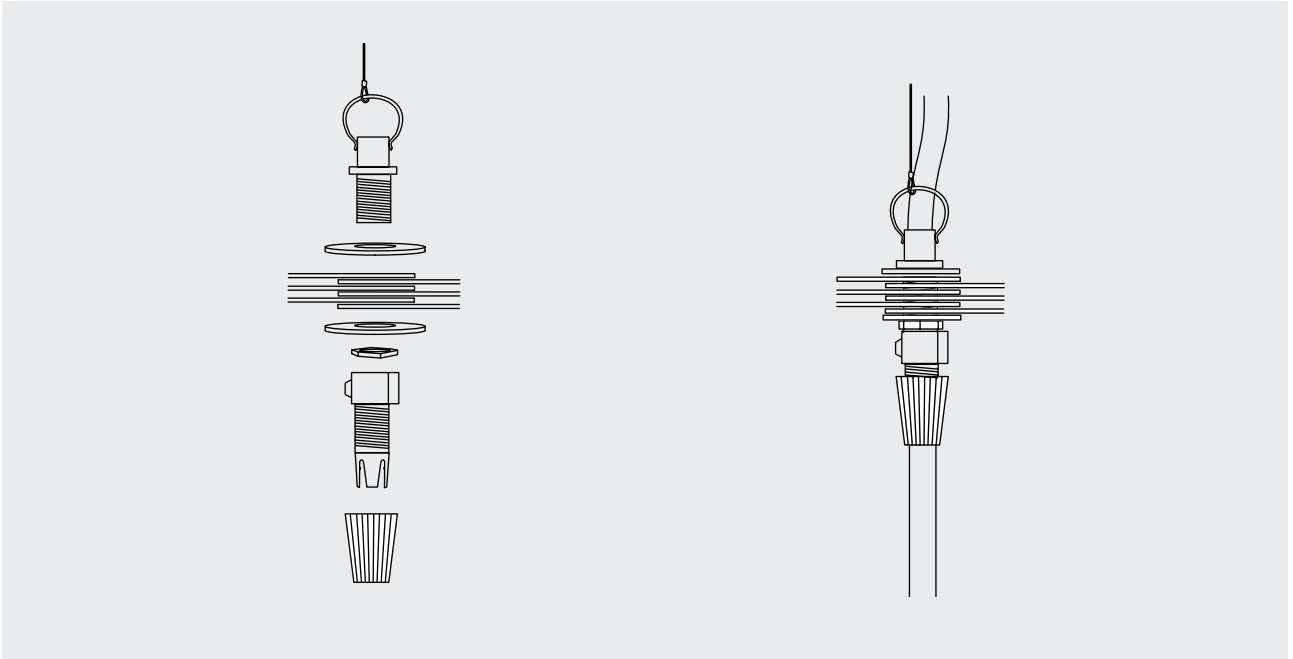

Fig 1. Base Plate

Installation

1000mm/39"
1200mm/47"
1600mm/63"



Step 1.

Follow the order of each component in diagram. Adjust the bulb / lamp to mid way in the pendant lightshade shown in Step 2 and then tighten.

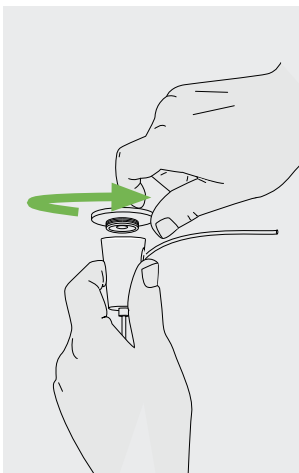

Step 2.
Unscrew baseplate.

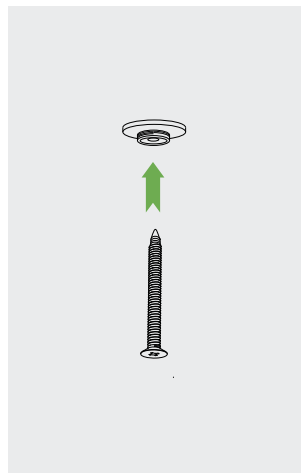

Step 3.
Use appropriate fixing screw to mount base plate (Fig.1).

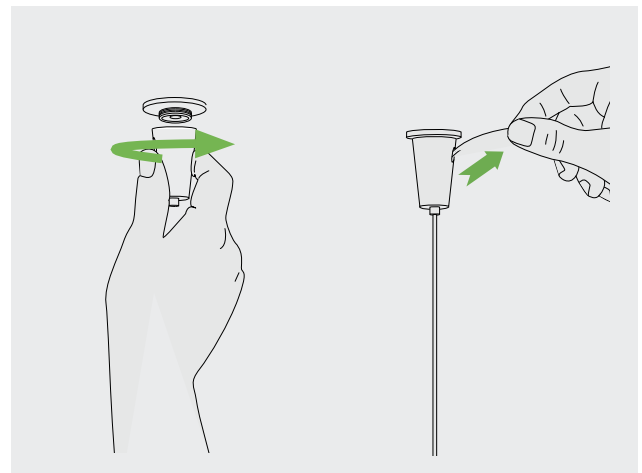

Step 4.
Remove cable from cone. Screw cone back onto baseplate. Re-insert cable and level light. Once desired position is set, trim excess cable.

Diagrams

400mm/16"

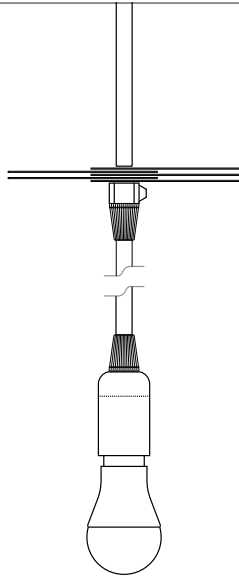

600mm/24"
800mm/31"

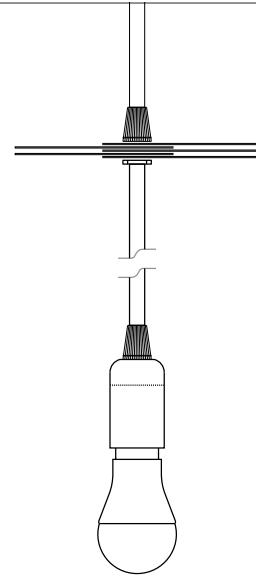

North America: E26, Max 60 Watts
120v AC 60hz
Rest of World: E14, Max 60 Watts
230-240v AC 50hz

North America: E26, Max 60 Watts
120v AC 60hz
Rest of World: E27, Max 60 Watts
230-240v AC 50hz



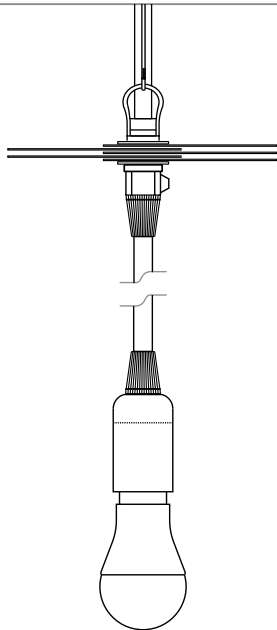



1000mm/39"
1200mm/47"
1600mm/63"



North America: E26, Max 60 Watts
120v AC 60hz
Rest of World: E27, Max 60 Watts
230-240v AC 50hz

David Trubridge PENDANT SERIES

 This luminaire is compatible with bulbs of the energy classes:

874/2012 

Finish Choices



Natural

All bamboo (our primary material) is secondary product, from renewable forests in China grown as a food source. We have visited these plantations and are satisfied with the quality of their systems.



Caramel

Caramel bamboo starts out as natural and is carbonised using steam to caramelize the natural sugars which darken the bamboo. This process creates a different look without using chemicals.



Black Stain

We use a water-borne stain which is made in New Zealand.



Painted Lights

We use an acrylic low VOC (volatile organic compound) paint that is made in New Zealand. Colour swatches are available in all retailers. See the Resene website for more info. www.resene.co.nz



Natural

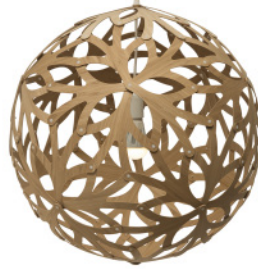

Caramel



Black Stain



Red



Orange



Yellow



Pink (Salmon)



Aqua



Lime



White One Side



White Two Sides

Contact

New Zealand
Showroom/Head office



Contact

+64 6 6500 204
office@davidtrubridge.com

Address

Corner Station Road &
Groome Place, Whakatu,
Hastings, Hawkes Bay,
New Zealand